

Ajută ursulețul să găsească drumul bun spre pădure.

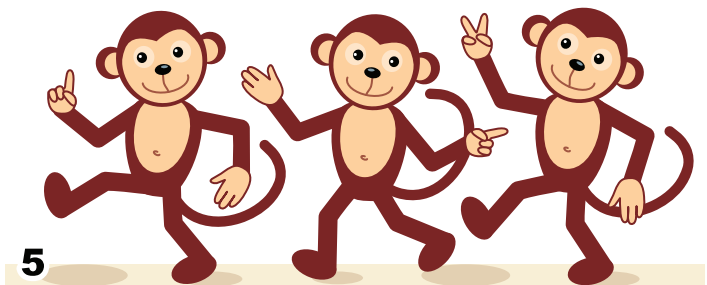

Dintre cele cinci desene, unul este imaginea în oglindă a altuia. Care sunt cele două desene?

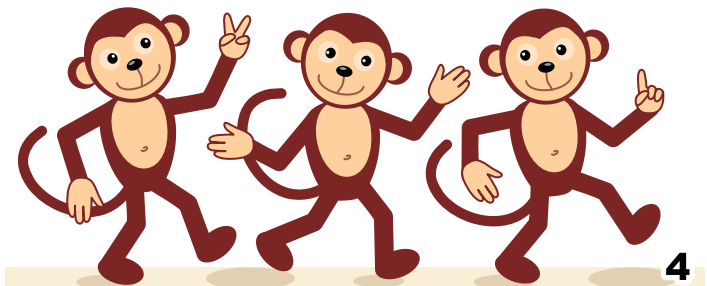
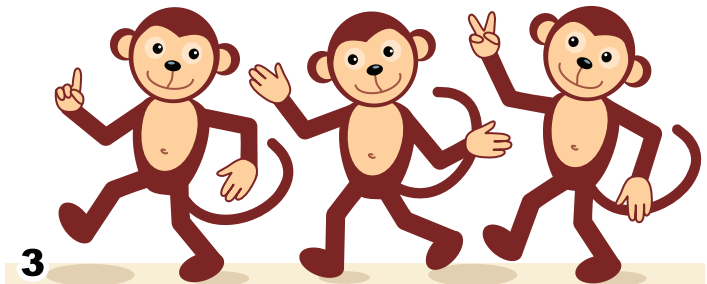
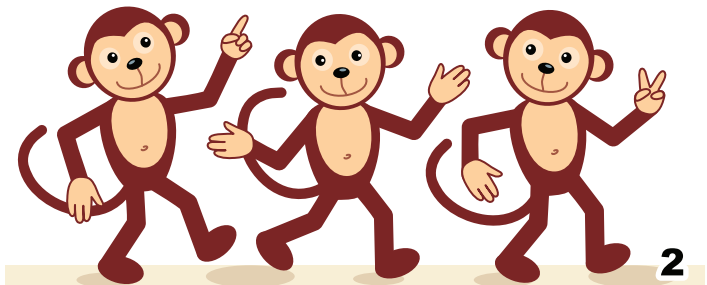
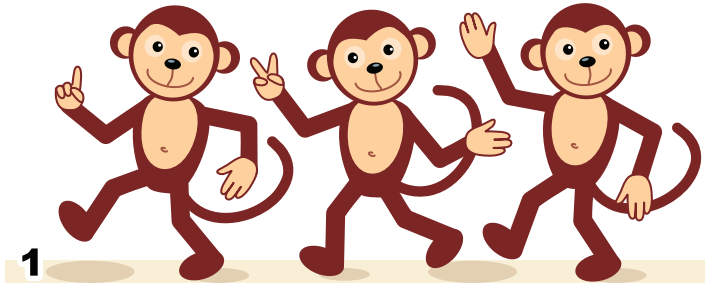

**Răspuns**

.....

Câți căței vezi mai jos?



Răspuns

.....

Potrivește perechile. Găsește desenul fără pereche.

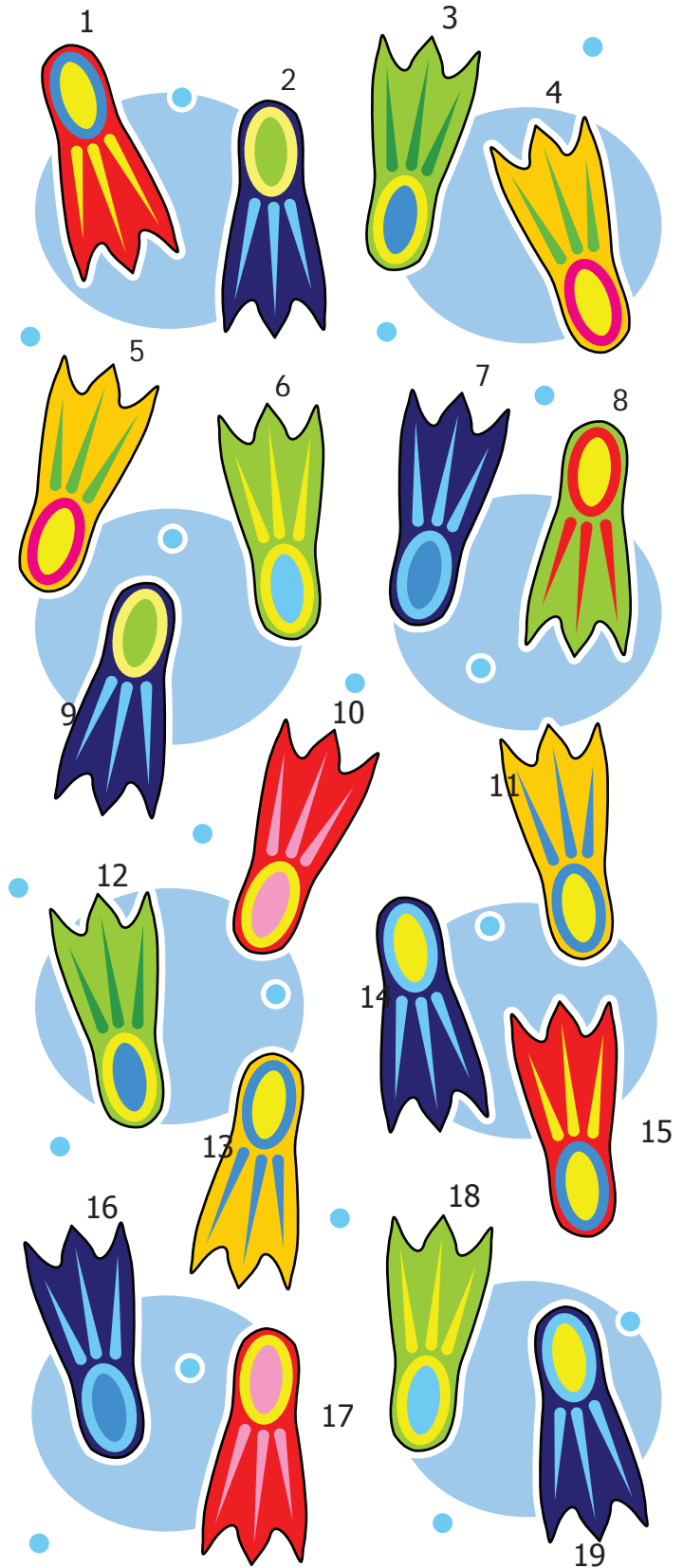
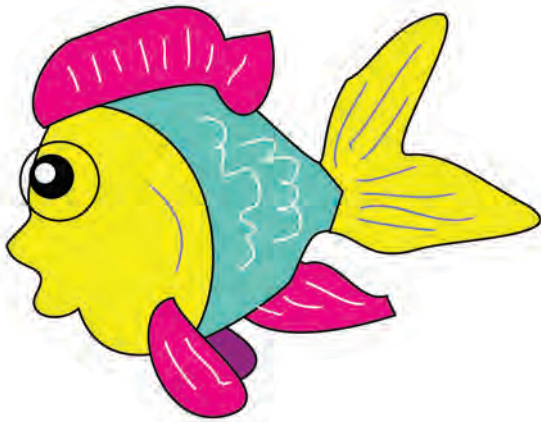

**Răspuns**

.....

.....

.....

.....

.....

.....

.....

Colorează desenul de jos ca în imaginea de sus.

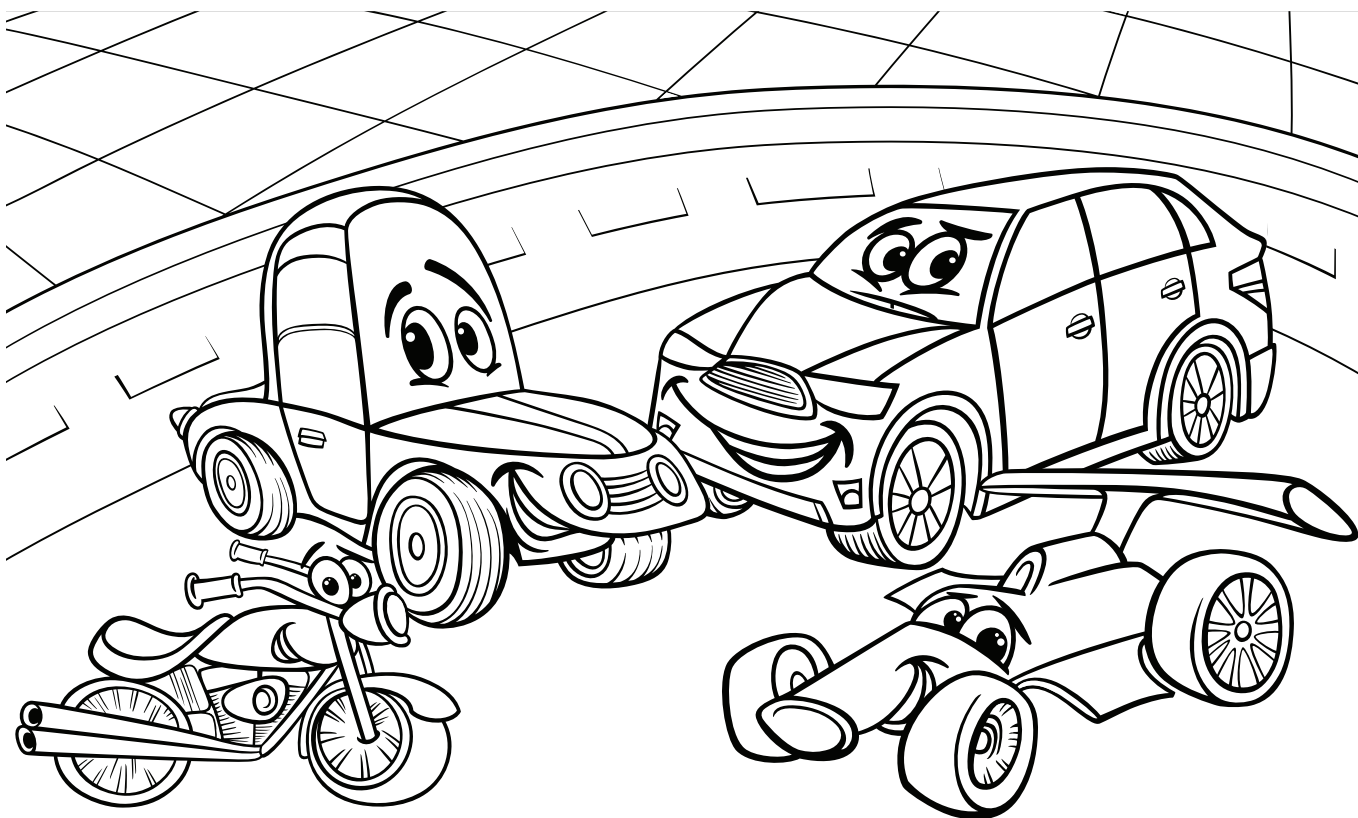

Unește punctele pentru a găsi obiectul ascuns.

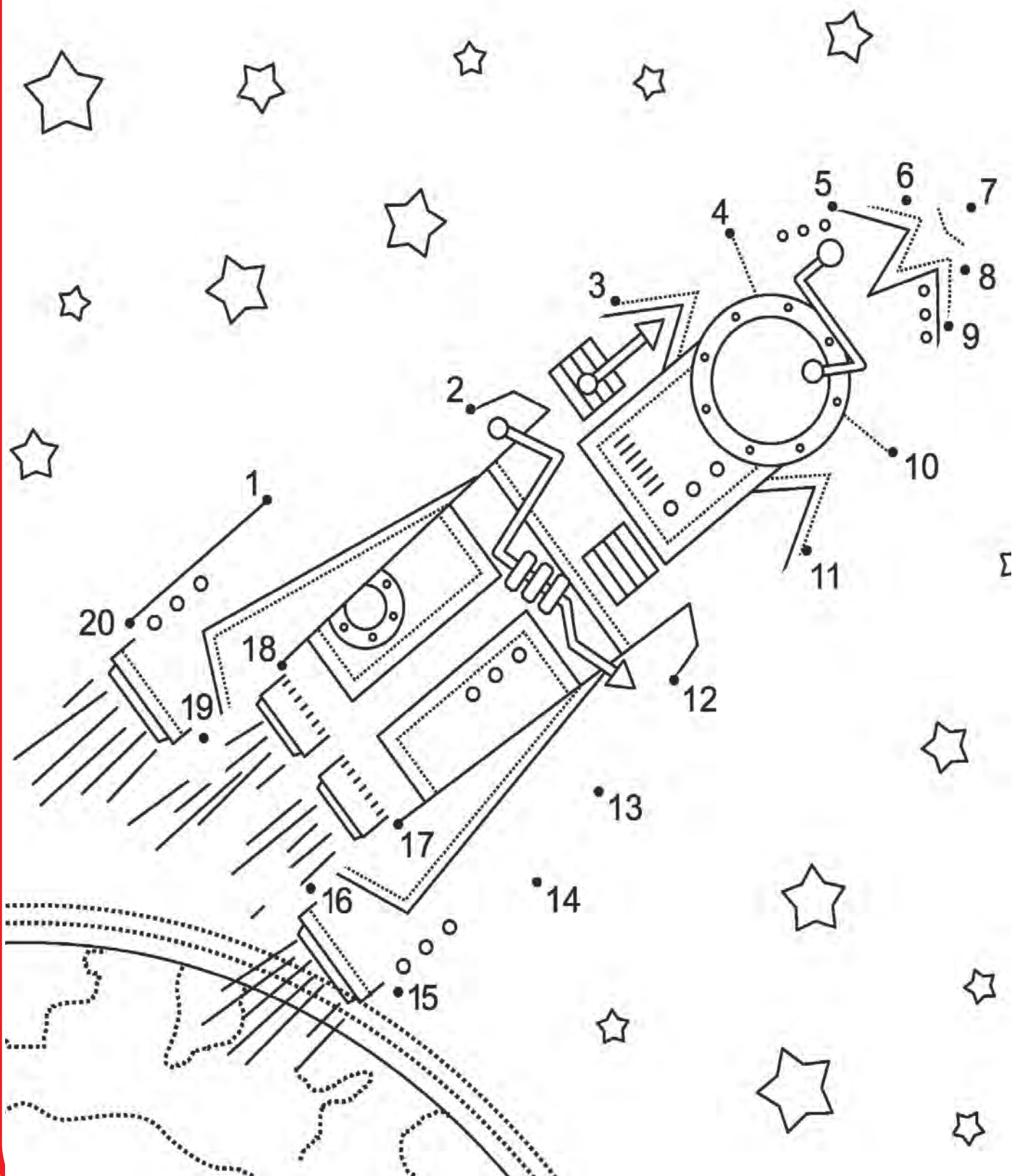

Găsește cei doi oameni de zăpadă identici.



Răspuns

.....

Ajută-l pe Moș Crăciun să găsească drumul  
cătrec sacul cu daruri pentru copii.

